

TECHNICAL DATA SHEET: 0021019
TIE OFF ANCHOR POINT-CARBON STEEL
PN: 400-114



Application:

Recommend use with Tuf-Tug Safe Climb Systems

Operating Temp. Range: 140°F (60°C) to -40°F (-40°C)

Corrosion Rating: C4 High per ISO 12944

Load Rating 5,000lbs (Rated to 1 Person)

APPLICABLE STANDARDS:

OSHA / ANSI Z359.18 / EN 795:2012 / EN 50308 / EN 365

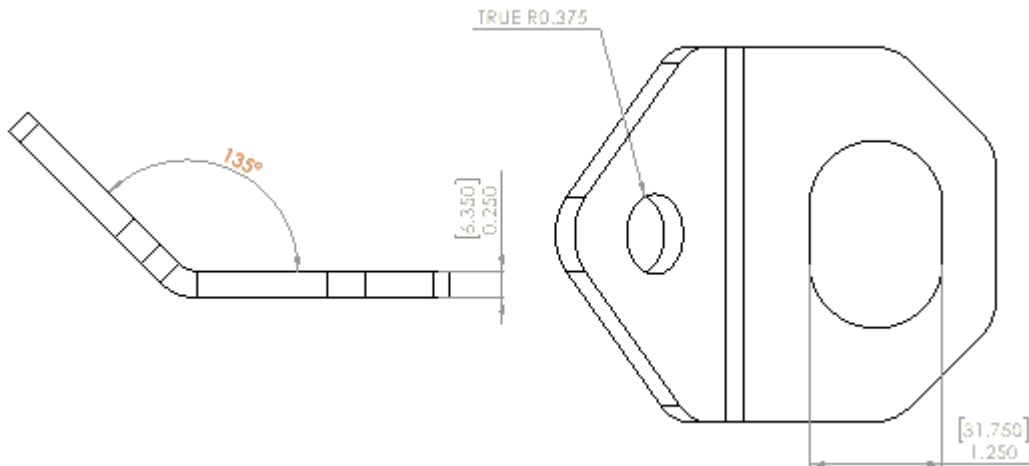
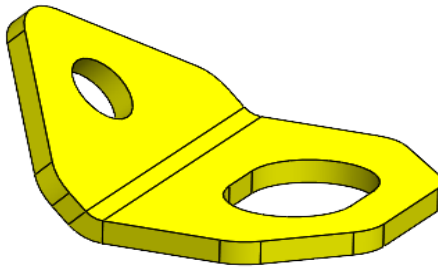

	QTY	Component	Material	Finish
1	1	Tie Off Anchor Point-1 person	A36 Carbon Steel	Safety Yellow