

TECHNICAL DATA SHEET: 0021017
TIE OFF ANCHOR POINT-STAINLESS STEEL
PN: 400-059



Application:

Recommend use with Tuf-Tug Safe Climb Systems

Operating Temp. Range: 140°F (60°C) to -40°F (-40°C)

Corrosion Rating: C5 High per ISO 12944

Load Rating 10,000lbs (Rated to 2 Person)

APPLICABLE STANDARDS:

OSHA / ANSI Z359.18 / EN 795:2012 / EN 50308 / EN 365

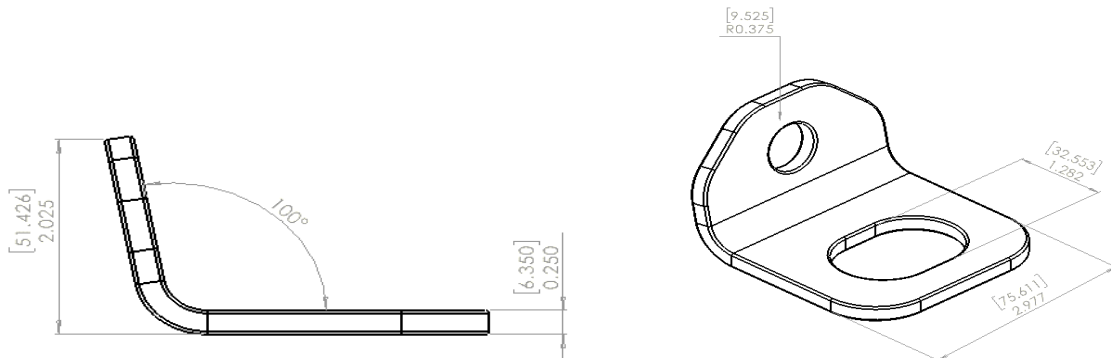
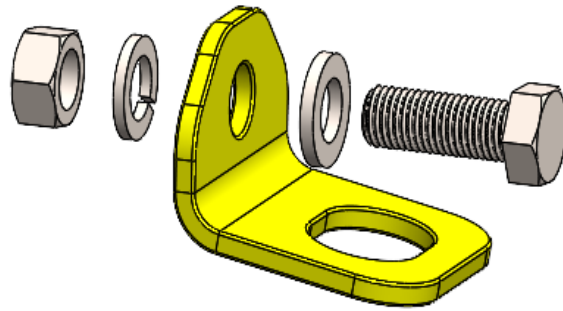

	QTY	Component	Material	Finish
1	1	Tie Off Anchor Point-2 person	316 Stainless Steel	Safety Yellow
2	1	M16 Flat Washer	316 Stainless Steel	Natural
3	1	M16x2x75mm Hex Head Screw	316 Stainless Steel	Natural
4	1	M16 Lock Washer	316 Stainless Steel	Natural
5	1	M16x2 Hex Nut	316 Stainless Steel	Natural