

TECHNICAL DATA SHEET: 0021029
TIE OFF ANCHOR POINT-STAINLESS STEEL
PN: 115-509



Application:

Recommend use with Tuf-Tug Safe Climb Systems

Operating Temp. Range: 140°F (60°C) to -40°F (-40°C)

Corrosion Rating: C4 High per ISO 12944

Load Rating 5,000lbs (Rated to 1 Person)

APPLICABLE STANDARDS:

OSHA / ANSI Z359.18

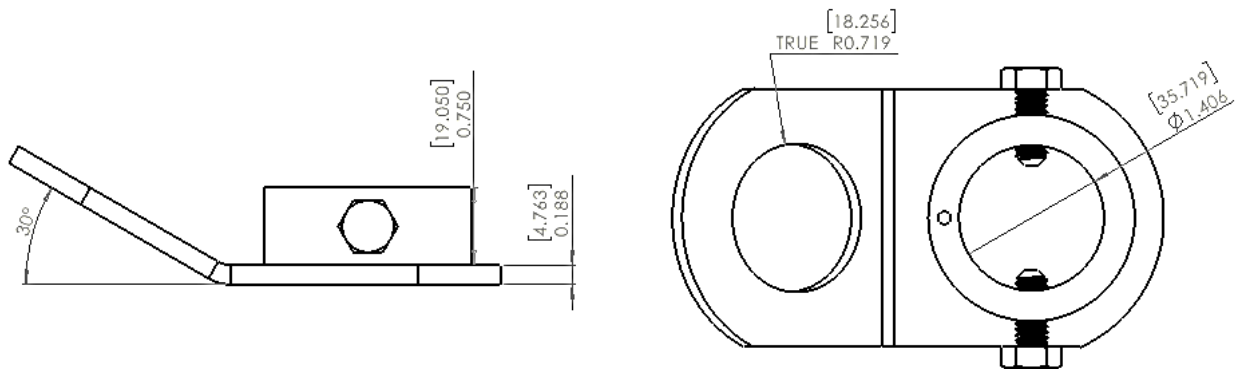

	QTY	Component	Material	Finish
1	1	Tie Off Anchor Point-1 person	304 Stainless Steel	Safety Yellow
2	1	Die Electric Collar	304 Stainless Steel	Safety Yellow
3	2	5/16-18x.750 Hex Head Cap Screw	304 Stainless Steel	Natural